

TYPHOON.R1



INFO
MORE LANGUAGES

www.varonaleds.com/arq_catalogue/TYPHOONR1.pdf







DESCRIPTION

TYPHOON is a series of very high power projectors. It can replace up to 600W metal halide fixtures for large area lighting. They give extremely bright high power luminous flux and have a very high-efficiency optics.

MATERIALS

Heavy duty aluminum alloy body
Tempered glass cover
Akzo Nobel powder coating

TECHNICAL











	CREE XP-G2 LEDs		230Vac/24Vdc
	IP65		3W@700mA
	-35°C/50°C		12780lm



REFERENCE

Reference	Series	Voltage	Power	Color	LED Qty.	Lumens
VL-2200-C-OP	TYPHOON.R1	230 Vac	280 W	C	90 pcs	12780 lm
VL-2201-RGB-OP	TYPHOON.R1	230 Vac	300 W	RGB	90 pcs	5304 lm
VL-2202-RGBW-OP	TYPHOON.R1	230 Vac	310 W	RGBW	90 pcs	7833 lm

COLORS

	Code: R 750nm
	Code: G 750nm
	Code: B 750nm
	Code: Y 750nm
<hr/>	
	Code: WW 3000K
	Code: NW 4500K
	Code: CW 6000K
<hr/>	
	Code: RGB DMX512
	Code: RGB - WW DMX512
	Code: RGB - W DMX512

DIMENSIONS

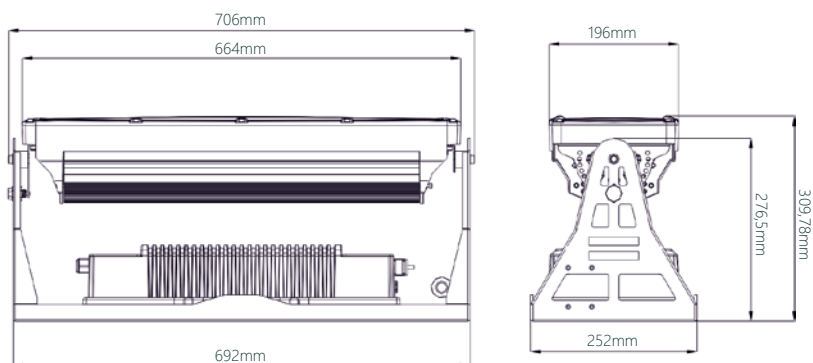

OPTICS

